

# Hygienewand

Typenliste



Unverbindliche  
Preisempfehlung  
ohne Montage,  
ohne Mehrwertsteuer

2023-1 - gültig ab 01.05.20

<b>Inhalt</b>	<b>Seite</b>
Farbübersicht	<b>3</b>
Systemübersicht	<b>4 - 5</b>
Anbindung an Tisch	<b>6</b>
Frei stehend	<b>7</b>
Deckenabhängung	<b>8</b>
Aufsatz für Akustikpanel	<b>8</b>

Es gelten die allgemeinen Lieferungs- und Zahlungsbedingungen von WINI Büromöbel:  
Druck bzw. Download über [www.wini.de/agb/](http://www.wini.de/agb/)

## Preisgruppe

PG A	Ausführung in Acryl 0,5cm transparent
PG M	Ausführung in Melamin 1,3cm

## Farbübersicht

### Wandelement und Kante

Dekor	Farbkürzel		Wandelement 1,3 cm
	Platte	Kante	
Apfel Meran Dekor	AD	AD	■
Buche Tirol Dekor	BH	BH	■
Buche Dekor	BD	BD	■
Lakeland Akazie Dekor	LL	LL	■
Kirsche Romana Dekor	KR	KR	■
Franz. Nussbaum Dekor	ND	ND	■
Eiche Milano Dekor	ME	ME	■
Eiche Odeon Dekor	EO	EO	■
Olive Sevilla Dekor	OD	OD	■
Revive Dekor	RD	RD	■
Titanweiß	TW	TW	■
Platin	PL	PL	■
Anthrazit	AZ	AZ	■
Beige	BE	BE	■
Beigegrau	GD	GD	■
Cuando	CD	CD	■
Porzellanweiß	P7	P7	■

ist eine Relief Oberfläche

## Gestell

Farbkürzel

Anbindungen

### Gestellausführung

Weißaluminium RAL 9006	W2	■
------------------------	----	---

## Systemübersicht

Presigruppen:

PG A Ausführung in Acryl 0,5cm transparent

PG M Ausführung in Melamin 1,3cm

## Rechteckform

Einsatzmöglichkeiten/Größen:

**Eckige Ausführung**

**Gerundete Ausführung**

Deckenabhängung

(B x H x T in cm) 100 X 80 X 0,5  
120 X 80 X 0,5

Anbindung an den Tisch

(B x H x T in cm) 80 X 80 X 0,5  
90 X 80 X 0,5  
120 X 80 X 0,5

Frei stehend

(B x H x T in cm) 80 X 60 X 0,5  
90 X 60 X 0,5  
120 X 60 X 0,5

Anbindung auf Akustikpanel

(B x H x T in cm) 120 X 20 X 0,5  
120 X 30 X 0,5

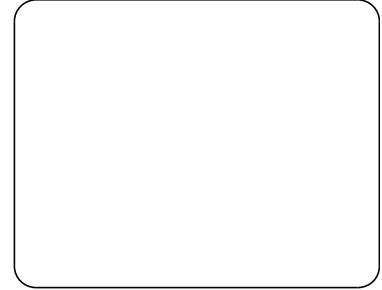
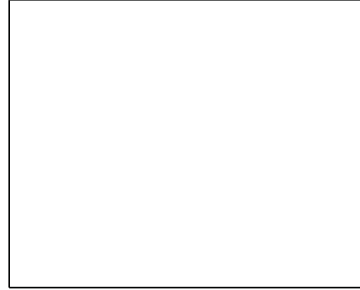

## Rechteckform mit Ausschnitt

Einsatzmöglichkeiten/Größen:

**Eckige Ausführung**

**Gerundete Ausführung**

Deckenabhängung

(B x H x T in cm) 100 X 80 X 0,5  
120 X 80 X 0,5

Anbindung an den Tisch

(B x H x T in cm) 80 X 80 X 0,5  
90 X 80 X 0,5  
120 X 80 X 0,5

Frei stehend

(B x H x T in cm) 80 X 60 X 0,5  
90 X 60 X 0,5  
120 X 60 X 0,5

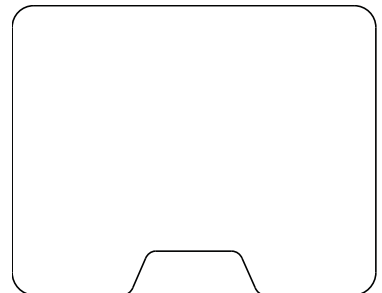
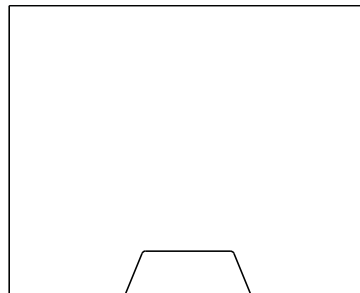

## L-Form

Einsatzmöglichkeiten/Größen:

**Eckige Ausführung**

**Gerundete Ausführung**

Anbindung an den Tisch

(B x H x T in cm) 110 X 80 X 0,5  
130 X 80 X 0,5

Frei stehend

(B x H x T in cm) 110 X 60 X 0,5  
130 X 60 X 0,5

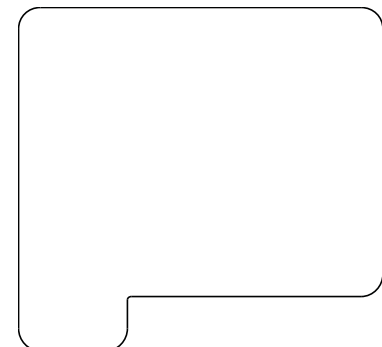
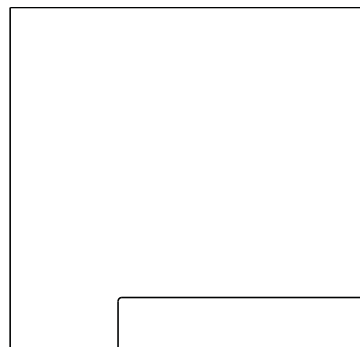

Alle Ausführungen auf Anfrage in Sondergrößen möglich!

## Systemübersicht

### Fußvarianten im Set

#### Anbindung Tischplatte

(1,9cm oder 2,5cm)

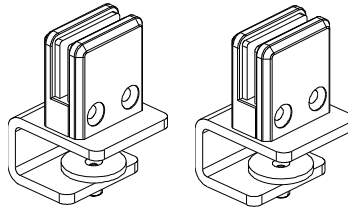

#### Anbindung Tischgestell

(WINEA ECO, WINEA PRO, WINEA FLOW, WINEA STARTUP)

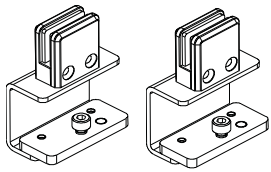
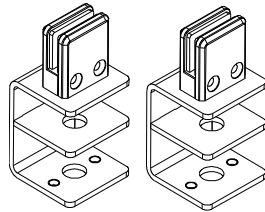

WINEA PRO

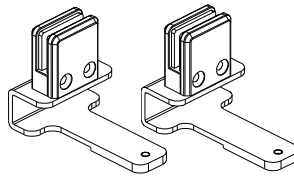

WINEA ECO

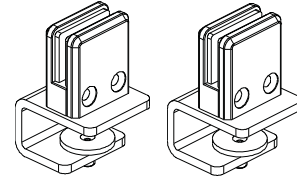

WINEA FLOW / WINEA STARTUP

#### Anbindung Akustikpanel

(WINEA SINUS, WINEA SONIC, WINEA X)

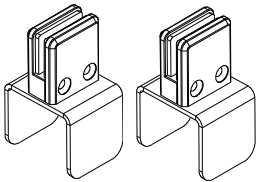

WINEA SINUS

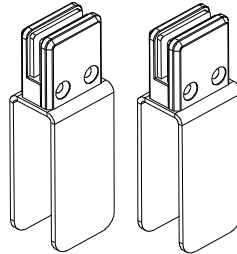

WINEA X

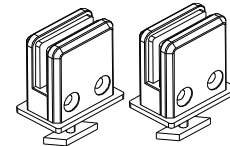

WINEA SONIC

#### Deckenabhängung

(Länge 200cm)

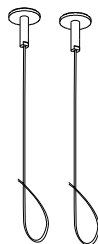

Zur Montage der Deckenabhängung ist bauseits die Beschaffenheit der Decke zu prüfen, um geeignete Schrauben und Dübel auswählen zu können.

#### Frei stehend

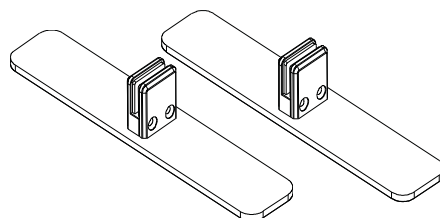

Metallfuß  
20 x 5 cm

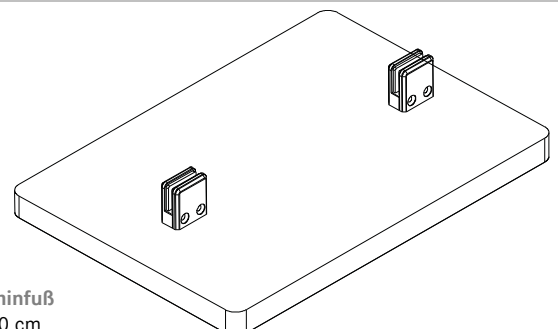

Melaminfuß  
40 x 20 cm

## Anbindung an den Tisch

Maße (B x H in cm)	80 x 80	90 x 80	120 x 80
--------------------	---------	---------	----------

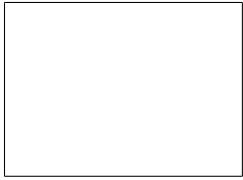

	SB 800800E	SB 900800E	SB 1200800E
PG A			
PG M			



	SB 800800R	SB 900800R	SB 1200800R
PG A			

Maße (B x H in cm)	110 x 80	130 x 80
--------------------	----------	----------

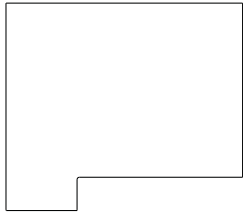

	SB 1100800LE	SB 1300800LE
PG A		

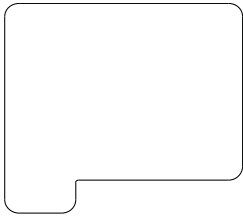

	SB 1100800LR	SB 1300800LR
PG A		

Maße (B x H in cm)	80 x 80	90 x 80	120 x 80
--------------------	---------	---------	----------

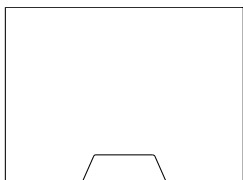

	SB 800800ED	SB 900800ED	SB 1200800ED
PG A			

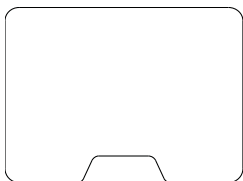

	SB 800800ER	SB 900800ER	SB 1200800ER
PG A			

Anbindungen	1,9 cm Tischplatte	2,5cm Tischplatte
-------------	--------------------	-------------------

Anbindung Tischplatte

	SB ABTP1901	SB ABTP2501
--	-------------	-------------

Anbindung Tischgestell

WINEA ECO	WINEA PRO	WINEA STARTUP	WINEA FLOW
SB ABWE01	SB ABPR01	SB ABSU01	SB ABFL01

## Frei stehend

Maße (B x H in cm)	80 x 60	90 x 60	120 x 60
--------------------	---------	---------	----------

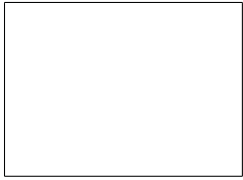

	SB 800600E	SB 900600E	SB 1200600E
PG A			
PG M			



	SB 800600R	SB 900600R	SB 1200600R
PG A			

Maße (B x H in cm)	110 x 60	130 x 60
--------------------	----------	----------

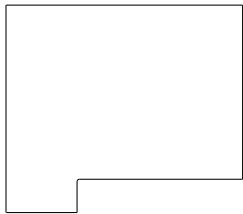

	SB 1100600LE	SB 1300600LE
PG A		

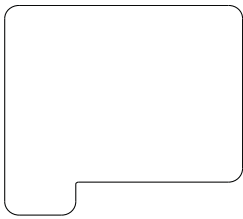

	SB 1100600LR	SB 1300600LR
PG A		

Maße (B x H in cm)	80 x 60	90x60	120 x 60
--------------------	---------	-------	----------

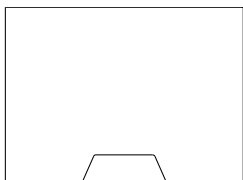

	SB 800600ED	SB 900600ED	SB 1200600ED
PG A			

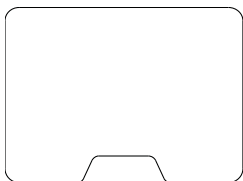

	SB 800600ER	SB 900600ER	SB 1200600ER
PG A			

## Frei stehende Füße

Metallfuß

SB ABFS02

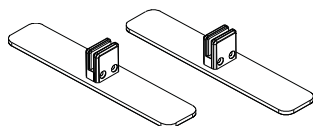

Holzfuß

SB ABFS03

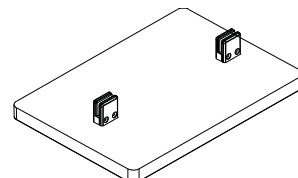

## Deckenpanel

Maße (B x H in cm)	100 x 80	120 x 80
--------------------	----------	----------

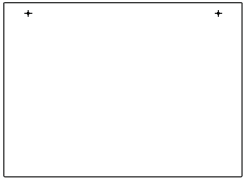

PG A      **SB 1000800DE**      **SB 1200800DE**

---



PG A      **SB 1000800DR**      **SB 1200800DR**

---

## Deckenabhängung (Seillänge 2m)



\_\_\_\_\_  
 \_\_\_\_\_  
**SB ABDA01**

## Aufsatz für Akustikpanel

Maße (B x H in cm)	120 x 20	120 x 30
--------------------	----------	----------



\_\_\_\_\_  
 \_\_\_\_\_  
**SB 1200200E**      **SB 1200300E**  
 PG A  
 PG M



\_\_\_\_\_  
 \_\_\_\_\_  
**SB 1200200R**      **SB 1200300R**  
 PG A

## Anbindung an Akustikpanel      WINEA SINUS      WINEA X      WINEA SONIC

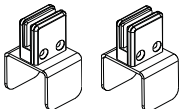

\_\_\_\_\_  
 \_\_\_\_\_  
**SB ABSI01**      **SB ABWX01**      **SB ABWY01**



**WINI Büromöbel**  
**Georg Schmidt GmbH & Co. KG**

Auhagenstraße 79  
31863 Coppenbrügge, OT Marienau  
Germany

Telefoon: +49(0)5156/979-0  
Telefax: +49(0)5156/979-100

E-Mail: [info@wini.de](mailto:info@wini.de)  
Internet: [www.wini.de](http://www.wini.de)